

1. Meet the letter Rr.



Red

Rr



Rose



Rabbit



Rain

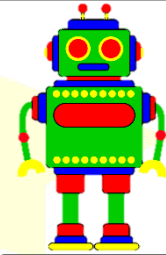

Robot

2. Take the rat to the letter Rr.



Rr

Pp

Ss

1. Meet the letter Ss.



Snail

Ss



Soap



Socks



Star



Squirrel

2. Take the snake to the letter Ss .

Ll

Cc

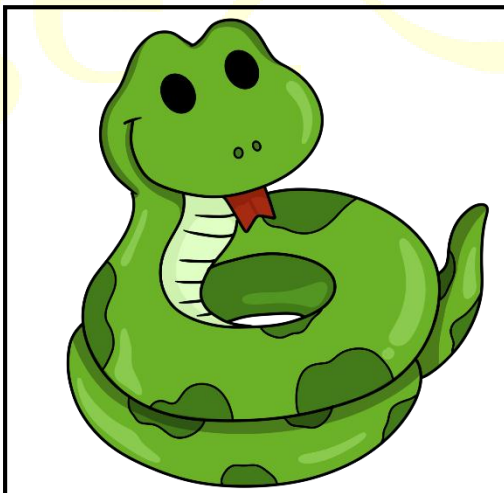

Gg

Ss

1. Meet the letter Tt.



Tiger

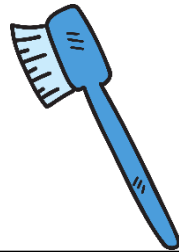
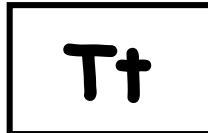

Toothbrush



Tomato



Television



Teapot

2. Circle the letter Tt.

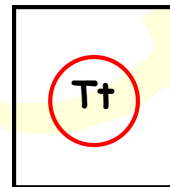
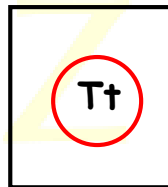
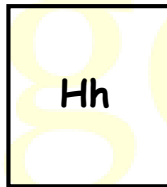
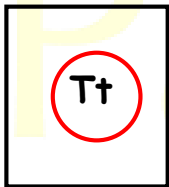

1.Meet the letter Uu.



Umbrella

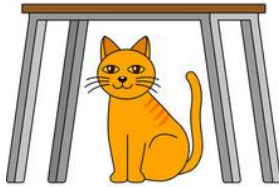

Under

Uu

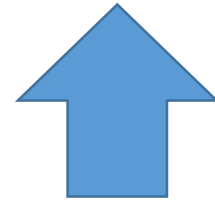

Up



Unhappy

1.Meet the letter Vv.



Violin

Vv



Vase



Vulture



Van



Vegetables

2. Colour the van with the letter Vv.



3. Match the same letters.

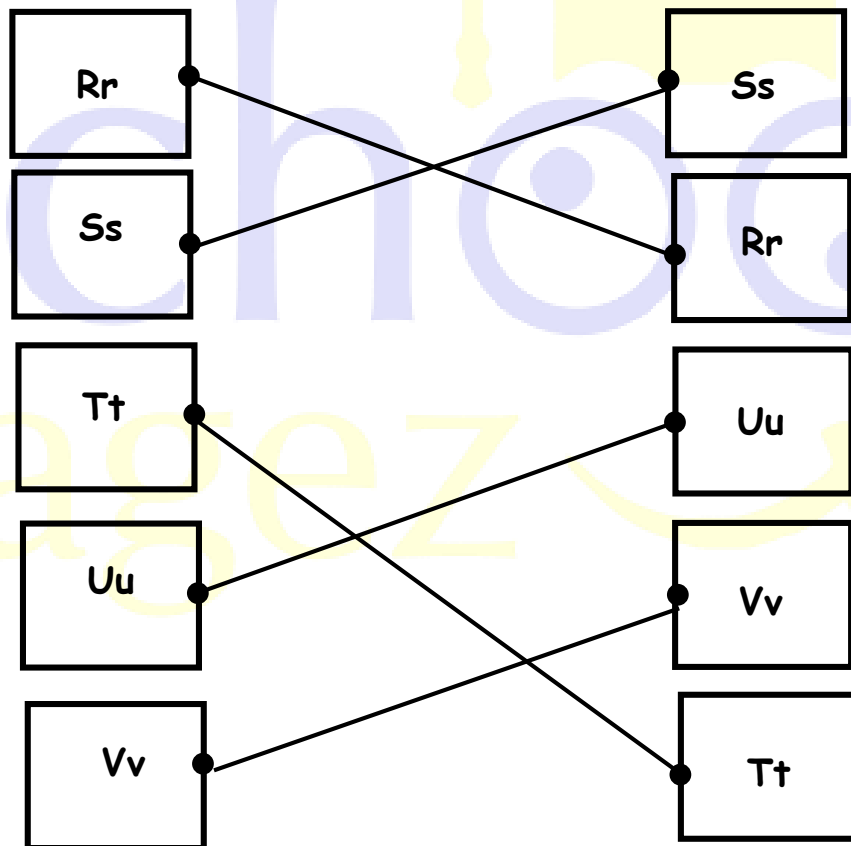

4.Circle the first letter of each picture .

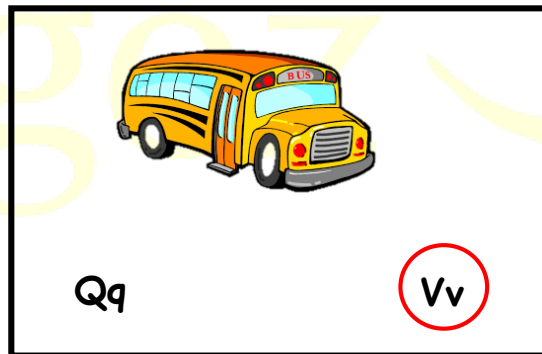
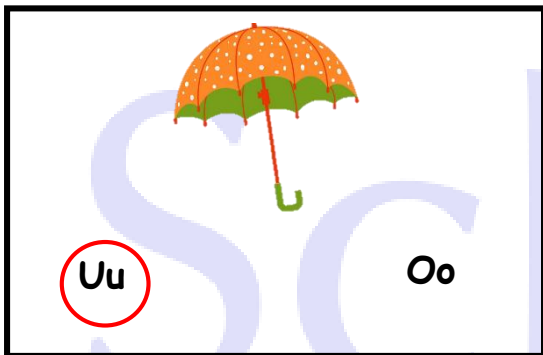
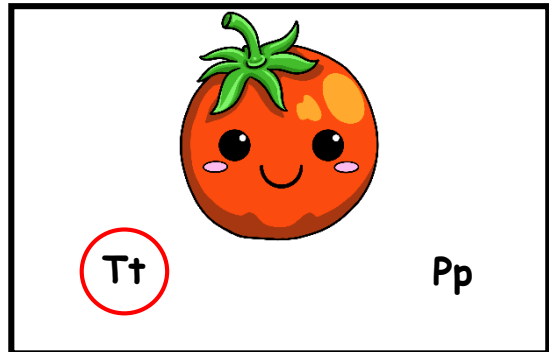
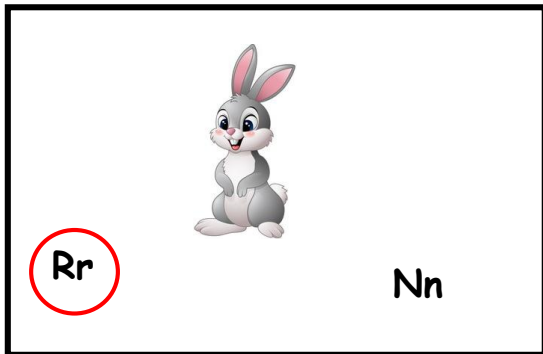

5. Trace the first letter of each picture.

Rr



Ss



Tt



Uu



Vv



6. Match the letter with picture.

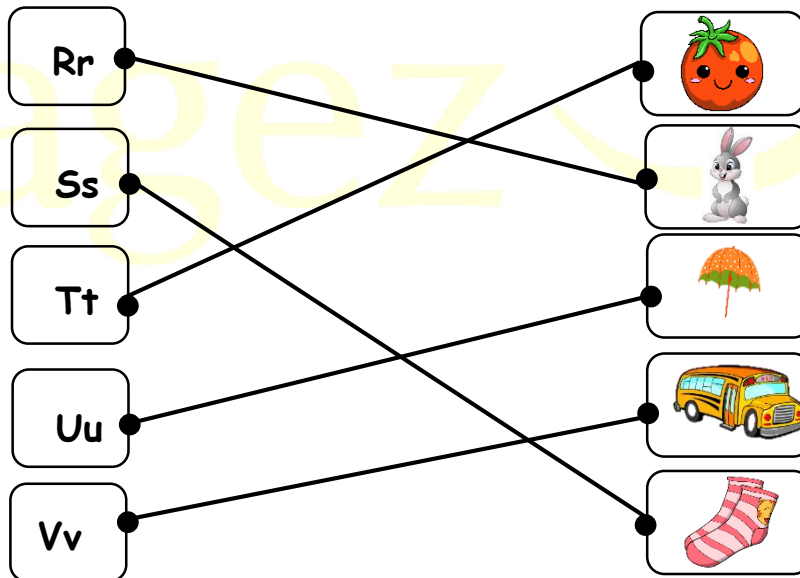

7. Match the same pictures.

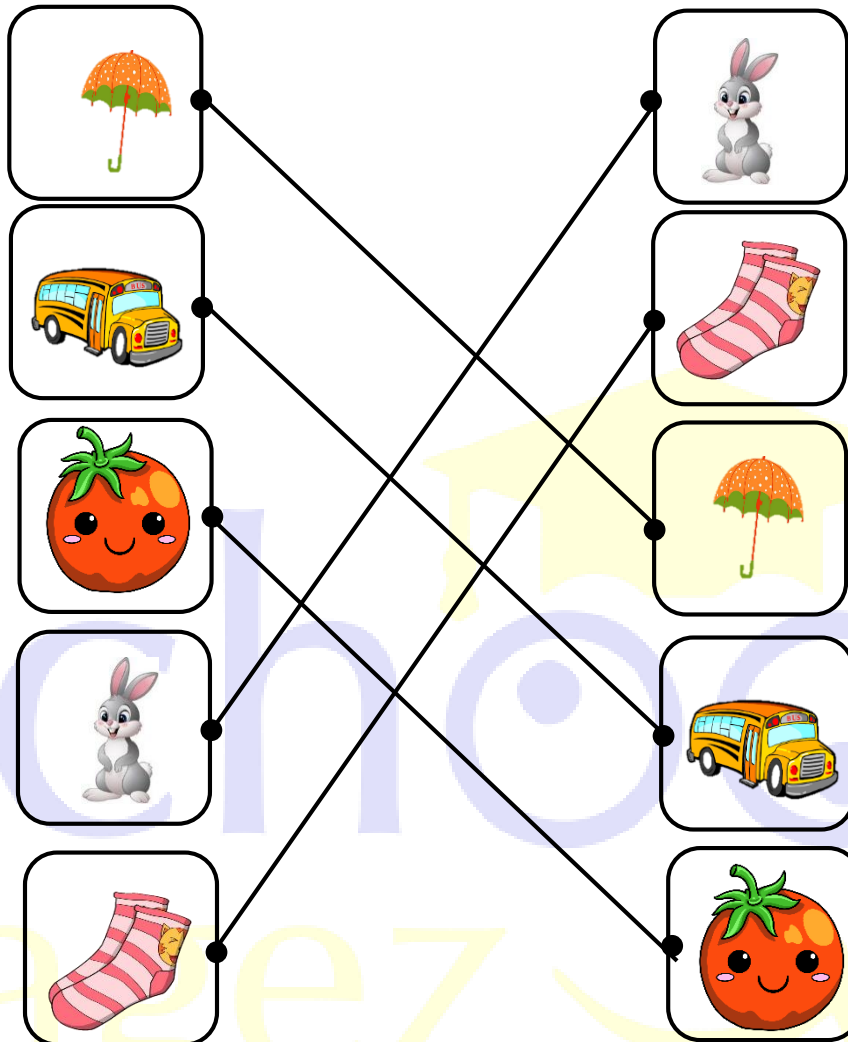

8. Trace the missing letters.

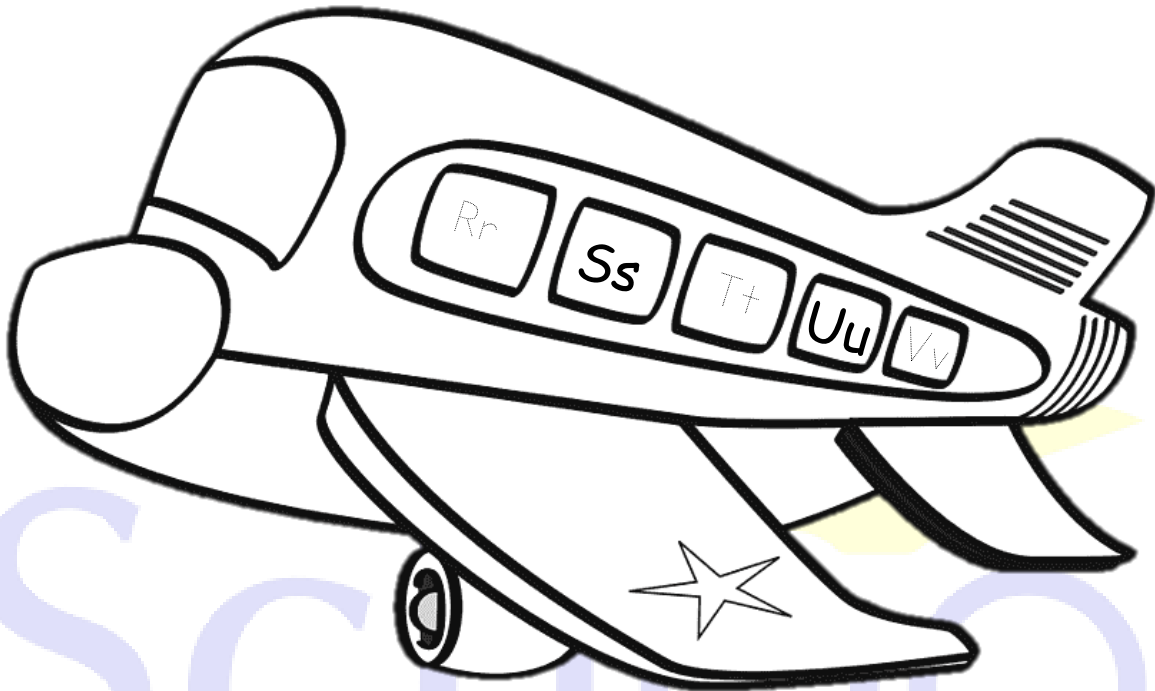

9. Take the snake to the letter Ss and colour the snake.

Rr

Ss



Tt

Vv

10. Choose the right option.

1) What's comes after Rr _____.

I. Ss

II. Ff

III. Oo

IV. Dd

2) Select the same picture  from the following pictures.

I.



II.



III.



IV.



3) What is the colour of tomato?

I. Red

II. Green

III. Yellow

IV. orange

4) Circle the word that start with letter u.

I.



II.



III.



IV.



5) What's comes between t _____ v".

I. e

II. j

III. u

IV. d