

1. Meet the letter Ee.

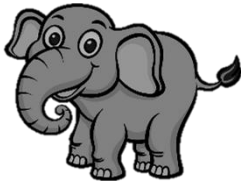

Elephant

Ee

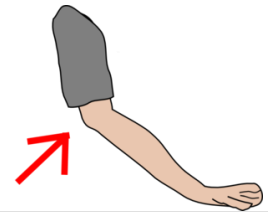

Elbow

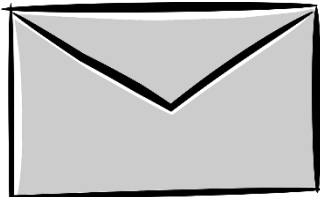

Envelope



Egg



Engine

2. Circle the letter Ee.

Ee

Dd

Ee

Bb

1. Meet the letter Ff.

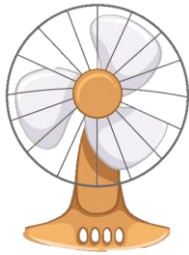

Fan



Foot

Ff



Flower



Fairy



Finger

2. Circle the letter Ff.

Ff

Ff

Ee

Ff

3. Circle the fish that are same.

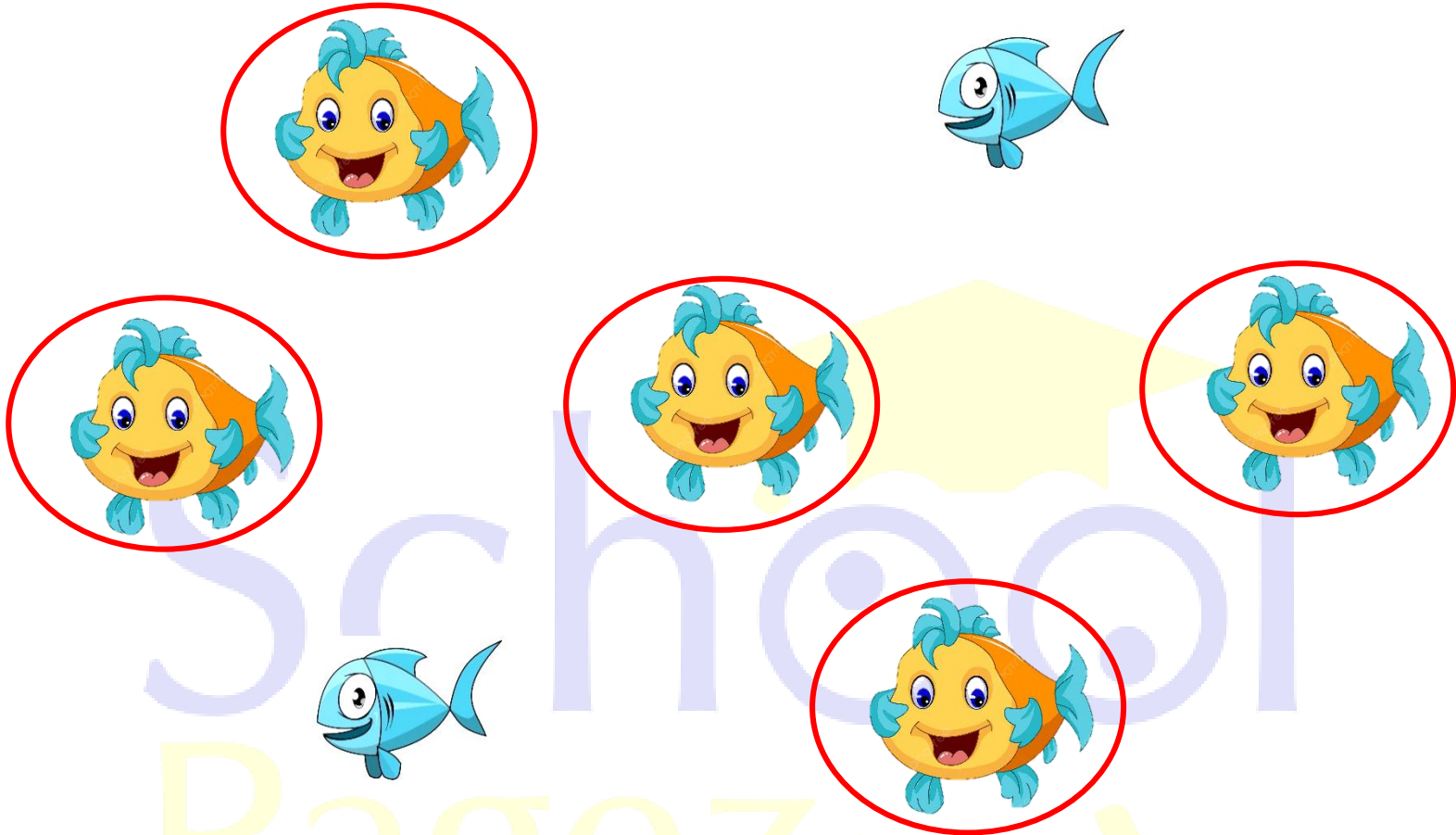

3. Match the letters that are same.

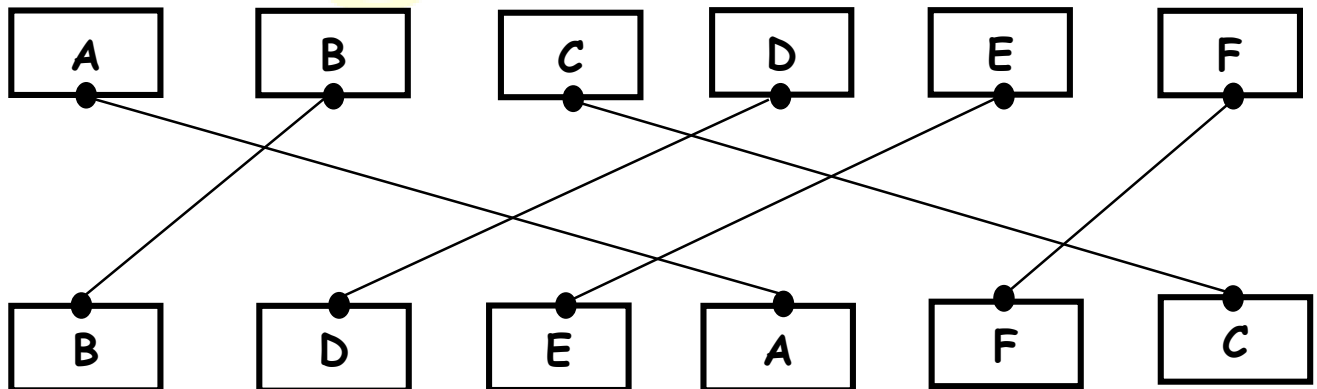

1. Meet the letter Gg.



Goat

Gg

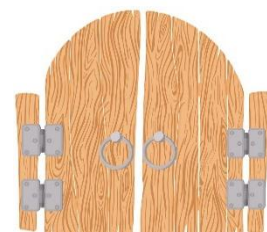

Gate



Guava



Girl



Gift

2. Circle the letter Gg.

Gg

Gg

Oo

Cc

1. Meet the letter Hh.



Hen

Hh



Hat



Hand



Hut



Horse

2. Circle the letter Hh.

Hh

Ff

Hh

3. Tick the right option.

1. What's comes after Ee_____ .			
I. Gg	II. Ff	III. Bb	IV. Dd
2. Select the goat from the following pictures.			
I.	II.	III.	IV.
3. What is the colour of apple?			
I. Red	II. Green	III. Yellow	IV. Pink
4. Circle the word that start with letter "H"			
I.	II.	III.	IV.
5. Choose the small case letter of "E "			
I. e	II. b	III. c	IV. d